

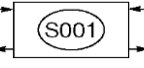



zehnder charleston

Подводка

Вид подключения	Код подключения	min кол-во секций	PPЦ, Евро
-----------------	-----------------	-------------------	-----------

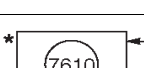
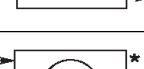
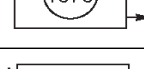
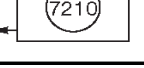

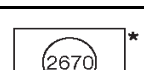
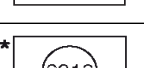
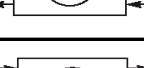
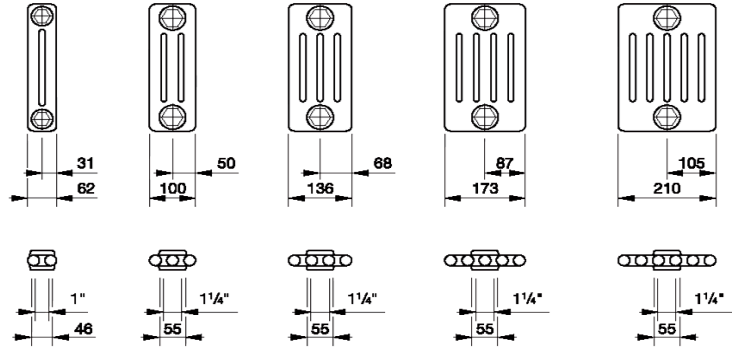
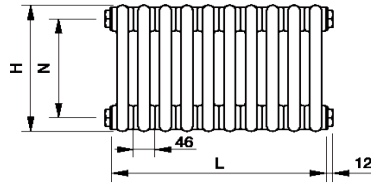
	N12 1/2 прох.	2	0,00
	N12 3/4	2	0,00
	N34 3/4	2	0,00
	N14 3/4	2	0,00
	N32 3/4	2	0,00
	N23 3/4	2	46,20
	N41 3/4	2	46,20
	N24 3/4	2	14,70
	N42 3/4	2	14,70
	N13 3/4	2	31,50
	N31 3/4	2	31,50



zehnder charleston

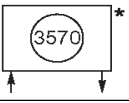
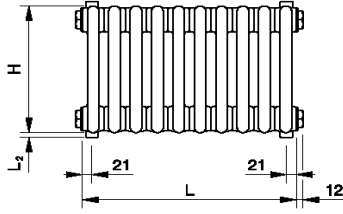
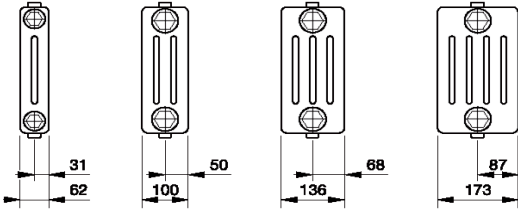
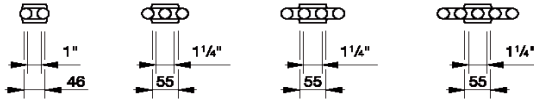
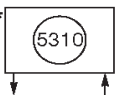
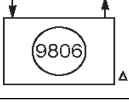
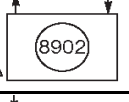
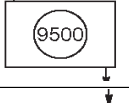
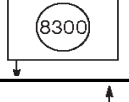
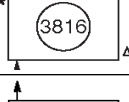

Подводка

Вид подключения	Код подключения	мин кол-во секций	PPЦ, Евро
-----------------	-----------------	-------------------	-----------

	N68 1/2	2	73,50	    
	N86 1/2	2	73,50	
	N57 1/2	2	90,30	
	N75 1/2	2	90,30	
	N58 1/2	2	58,80	
	N76 1/2	2	58,80	
	N67 1/2	2	105,00	
	N85 1/2	2	105,00	

zehnder charleston

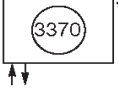
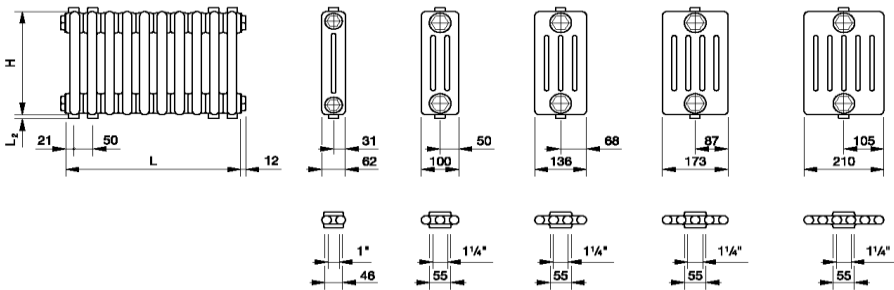
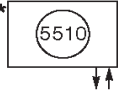
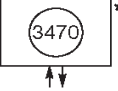
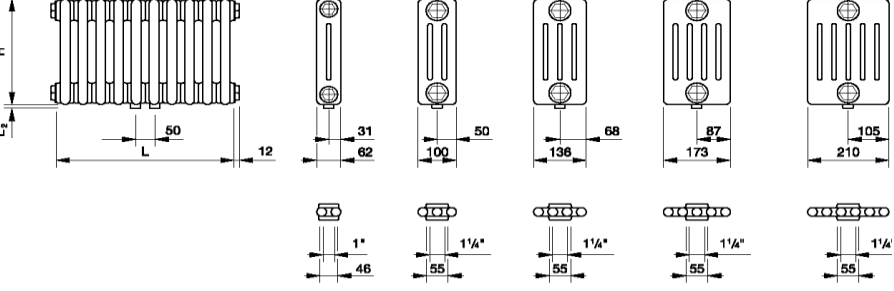
Подводка

Вид подключения	Код подключения	min кол-во секций	PPЦ, Евро	
	N69 1/2	4	71,40	
	N89 1/2	4	71,40	
	N96 1/2	4	147,00	
	N98 1/2	4	147,00	

# zehnder charleston

## Подводка

Вид подключения	Код подключения	min кол-во секций	PPЦ, Евро	
	N69 ТВВ	4	147,00	
	N89 ТВВ	4	147,00	
	N69 ТВН	4	239,40	
	N89 ТВН	4	239,40	
	N96 ТВВ	6	225,75	
	N98 ТВВ	6	225,75	
	N68 ТВВ	4	147,00	
	N86 ТВВ	4	147,00	

# zehnder charleston

Подводка

Вид подключения	Код подключения	min кол-во секций	PPЦ, Евро
-----------------	-----------------	-------------------	-----------

	N2270 3/4 N=	4	136,50
	N6610 3/4 N=	4	136,50

N = 500, 600, 619, 700, 800, 819, 900 мм. \*При заказе указывайте межцентровое расстояние

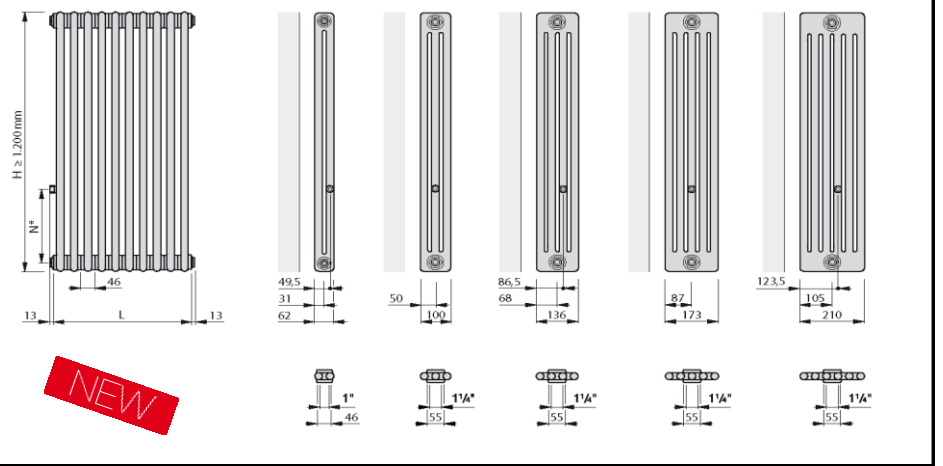

	N3580		0,00
	N5390		0,00

\* Charleston Turned

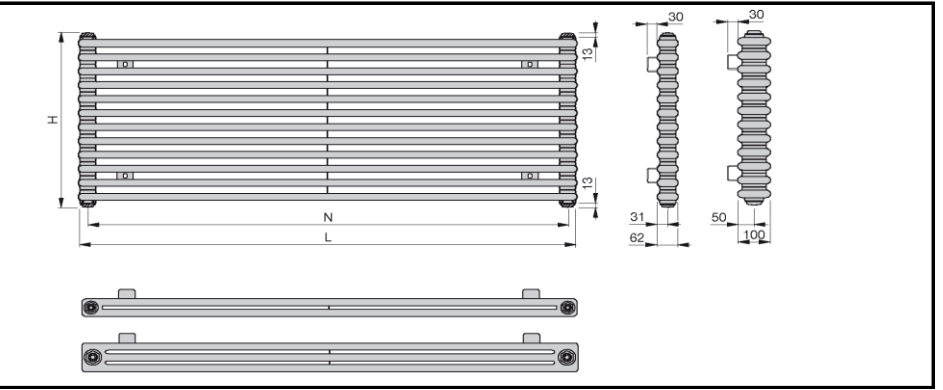

	N1280		94,50
	N7690		94,50

\* Charleston Turned

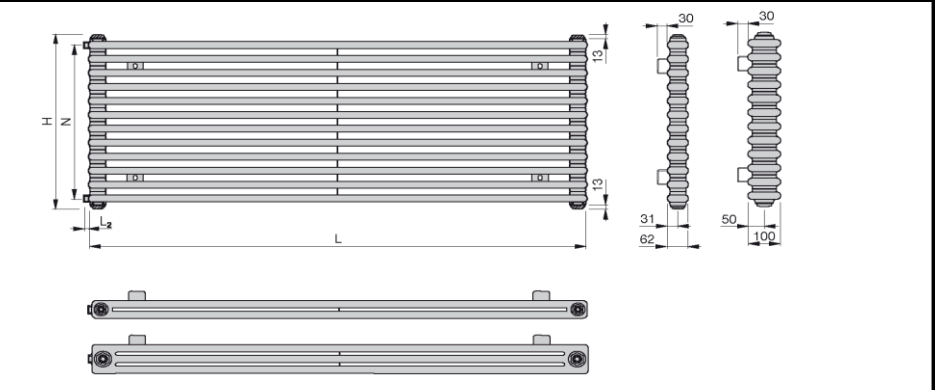

	N1680		80,85
	N7290		80,85

\* Charleston Turned

